

How Arduino Yun Rev. 2 Connect to IoTtalk?

Dr. Yun-Wei Lin
NCTU

Arduino Yún Rev. 2

- 與其他Arduino板子不同之處
 - ATmega32U4 (MCU), 運行Arduino環境
 - Atheros AR9331 (SoC), 運行Linux環境 (Linino)
 - Linino以OpenWRT為基礎修改而成
 - Ethernet
 - WiFi
 - USB A埠
 - micro SD卡插槽

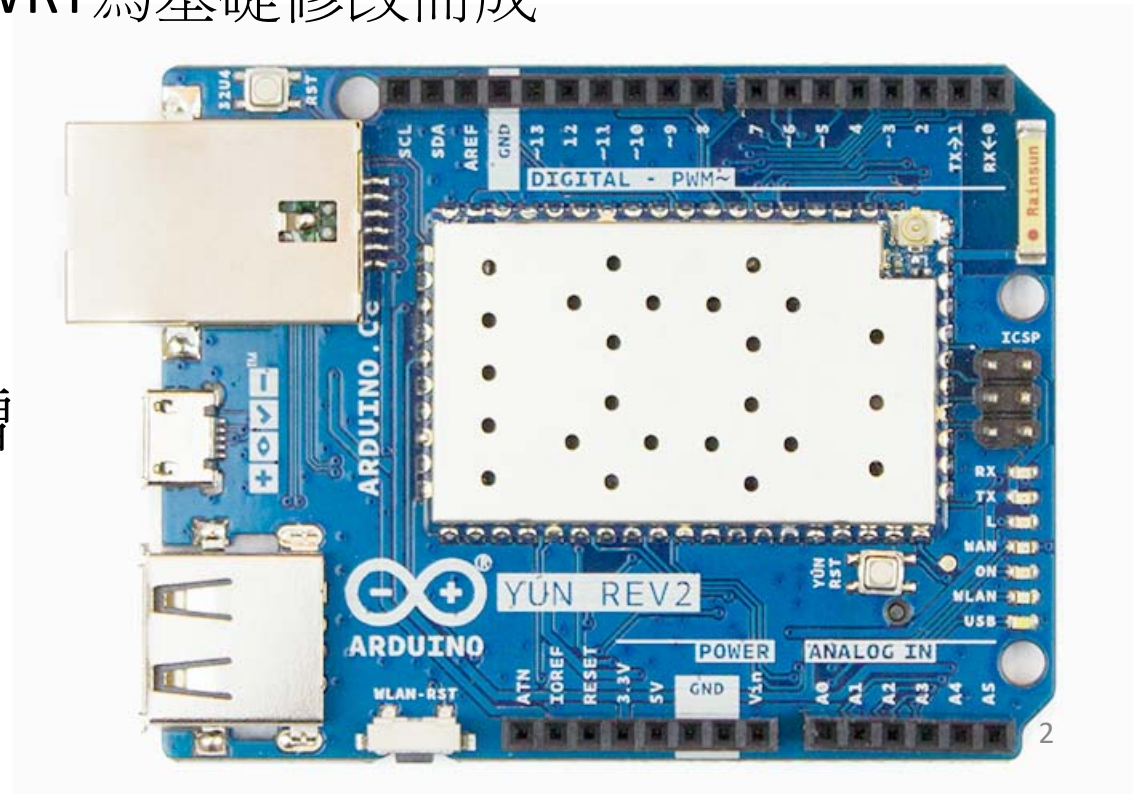

Arduino Yún Rev. 2上的三顆按鈕

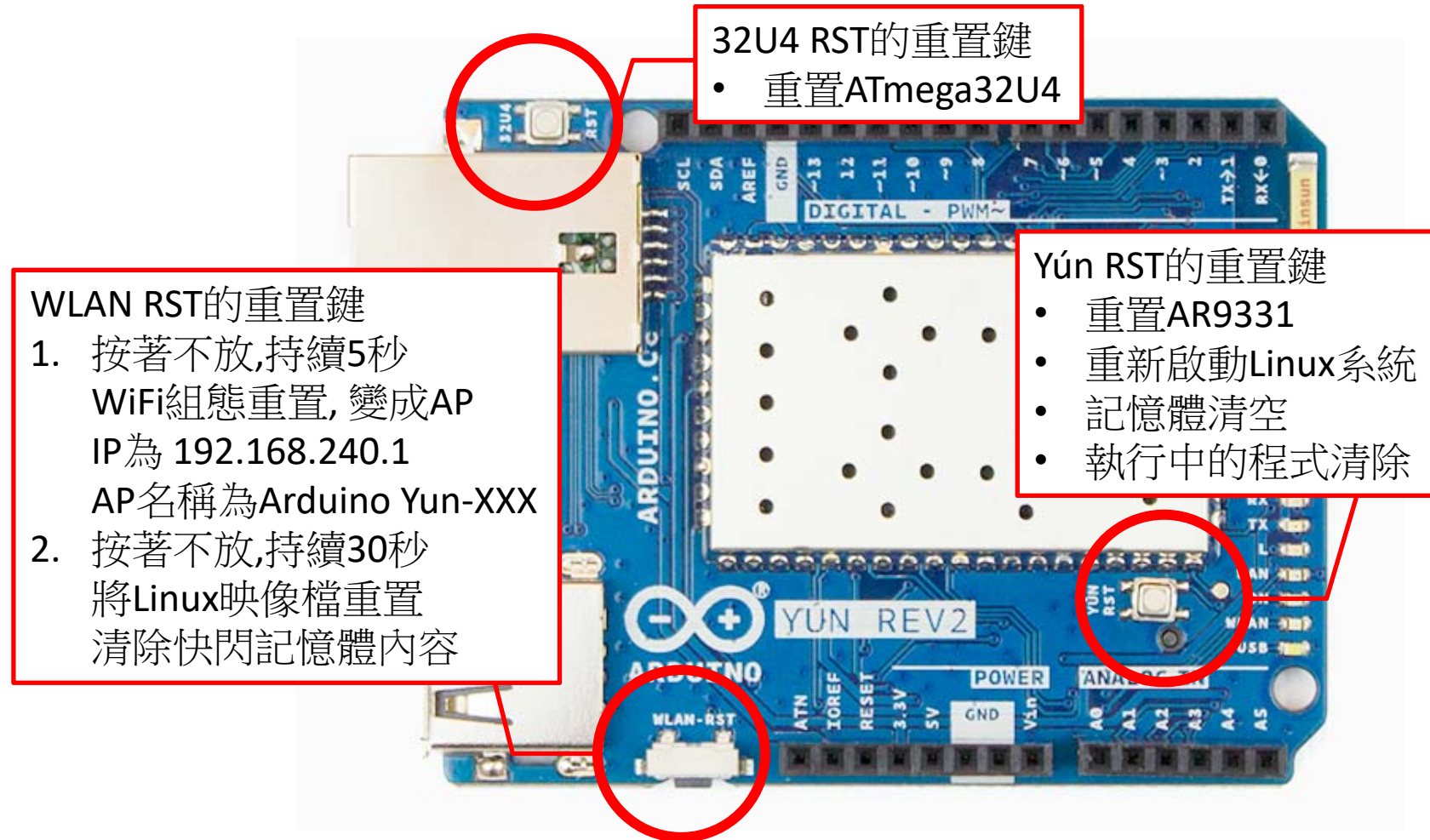

Arduino Yún上的三顆按鈕

32U4 RST的重置鍵

- 重置ATmega32U4

WLAN RST的重置鍵

1. 按著不放,持續5秒
WiFi組態重置, 變成AP
IP為 192.168.240.1
AP名稱為Arduino Yun-XXX
2. 按著不放,持續30秒
將Linux映像檔重置
清除快閃記憶體內容

Yún RST的重置鍵

- 重置AR9331
- 重新啟動Linux系統
- 記憶體清空
- 執行中的程式清除



電壓, 電流, 與電阻

- Arduino Yún針腳輸出5v, 40ma
- 紅光LED工作電壓約為2.2v, 20ma
- 所以要確保LED壽命較長，需要降壓2v~3v
- 根據 $V=I * R$
 - $2v=20ma * R$, $R=100$ 歐姆

設定 Arduino Yun 連到 Wi-Fi AP

0. 下載Arduino IDE

The screenshot shows a web browser window with the URL <https://www.arduino.cc/en/Main/Software>. The page features a teal navigation bar with the Arduino logo and menu items: HOME, STORE, SOFTWARE, EDU, RESOURCES, COMMUNITY, HELP, a search icon, a shopping bag icon, and SIGN IN. The main content area is titled "Download the Arduino IDE" and includes a large circular logo with a minus and plus sign. The text describes the ARDUINO 1.8.8 IDE, its open-source nature, and its compatibility with Windows, Mac OS X, and Linux. It also provides links for Windows installers, Windows apps, Mac OS X versions, and Linux versions (32 bits, 64 bits, ARM). At the bottom, there are sections for "HOURLY BUILDS" (with a "LAST UPDATE 6 December 2018 22:24:56 GMT" badge) and "BETA BUILDS" (with a "BETA" badge).

檔案 (F) 編輯 (E) 檢視 (V) 歷史 (S) 書籤 (B) 工具 (T) 說明 (H)

Arduino - Software

<https://www.arduino.cc/en/Main/Software>

HOME STORE SOFTWARE EDU RESOURCES COMMUNITY HELP

Download the Arduino IDE



ARDUINO 1.8.8

The open-source Arduino Software (IDE) makes it easy to write code and upload it to the board. It runs on Windows, Mac OS X, and Linux. The environment is written in Java and based on Processing and other open-source software.

This software can be used with any Arduino board. Refer to the [Getting Started](#) page for Installation instructions.

- Windows** Installer, for Windows XP and up
Windows ZIP file for non admin install
- Windows app** Requires Win 8.1 or 10
[Get](#)
- Mac OS X** 10.8 Mountain Lion or newer
- Linux** 32 bits
- Linux** 64 bits
- Linux** ARM

[Release Notes](#)
[Source Code](#)
[Checksums \(sha512\)](#)

HOURLY BUILDS

LAST UPDATE
6 December 2018 22:24:56 GMT

Download a **preview of the incoming release** with the most updated features and bugfixes.

[Windows](#)

BETA BUILDS

BETA

Download the **Beta Version** of the Arduino IDE with experimental features. This version should NOT be used in production.

[Windows](#)
[Mac OS X \(Mac OS X Mountain Lion or later\)](#)

1. 將micro usb線串起ArduinoYun與PC
2. 在IDE上選則對應的COM port

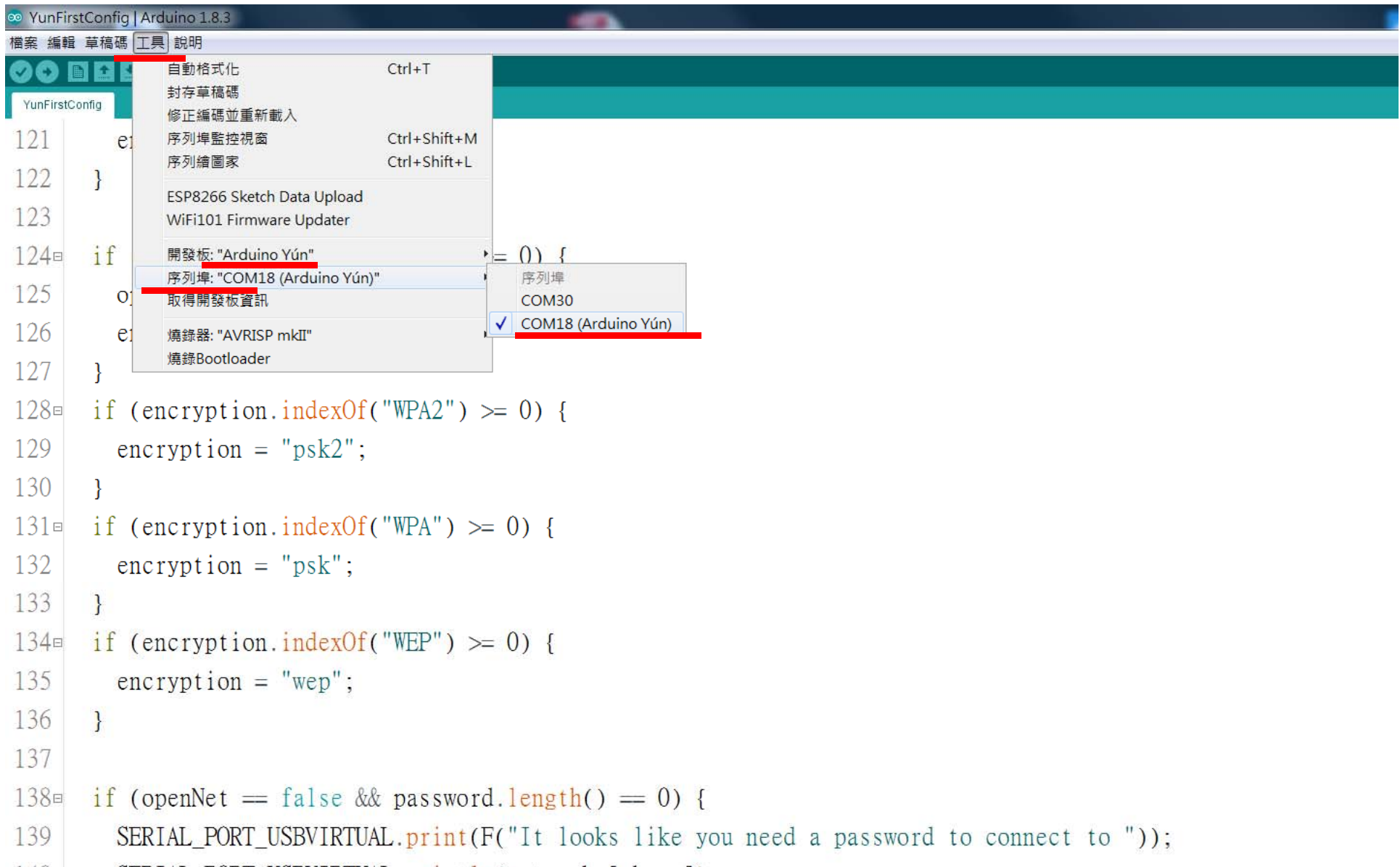

Arduino Yún 與電腦連結之驅動安裝

1. 接上Arduino Yun
2. 進入裝置管理員
3. 找到其他裝置中的Arduino
4. 於其上點右鍵選擇更新驅動程式
5. 將驅動程式目錄選擇到 Arduino IDE目錄下即可找到驅動程式進行安裝

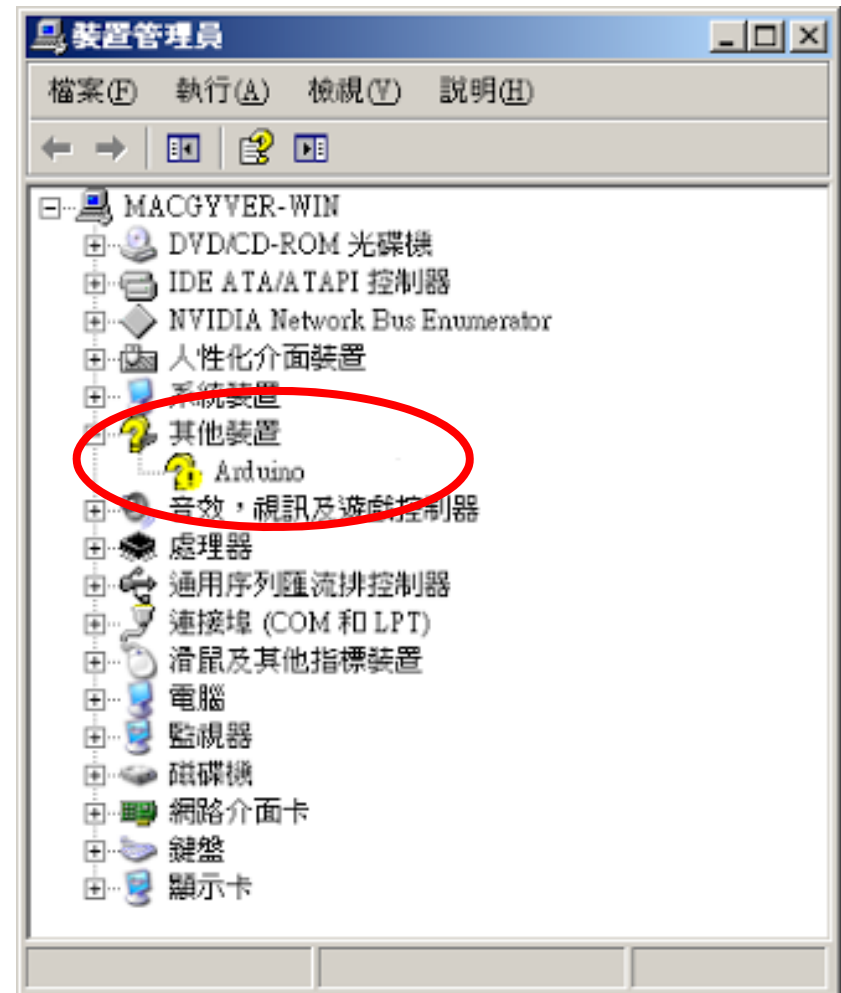

Arduino Yun與電腦連結成功

- 驅動程式若是安裝成功
可在連接埠內看到
Arduino Yun (COMX)
X=1,2,3,...

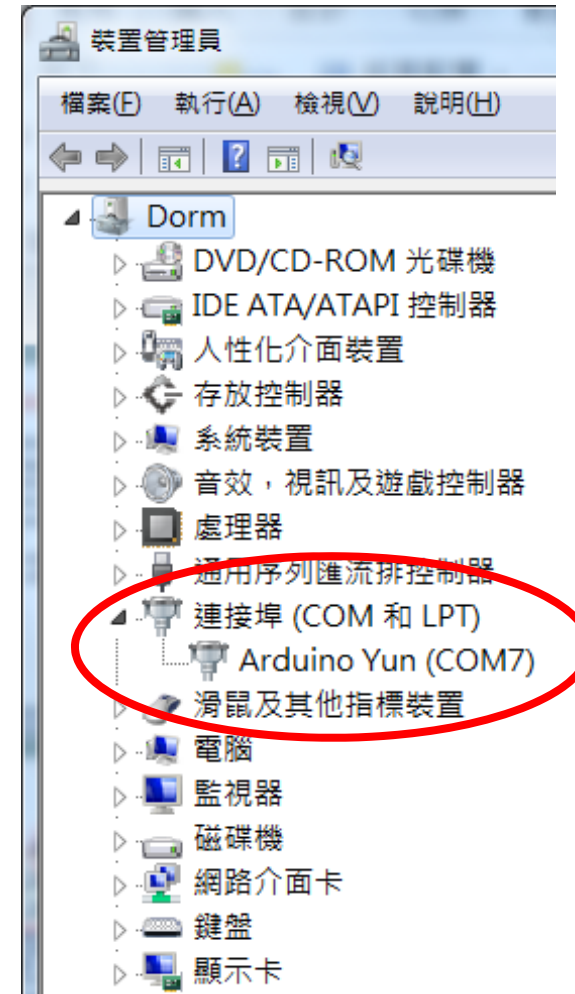

3. 選擇範例程式YunFirstConfig

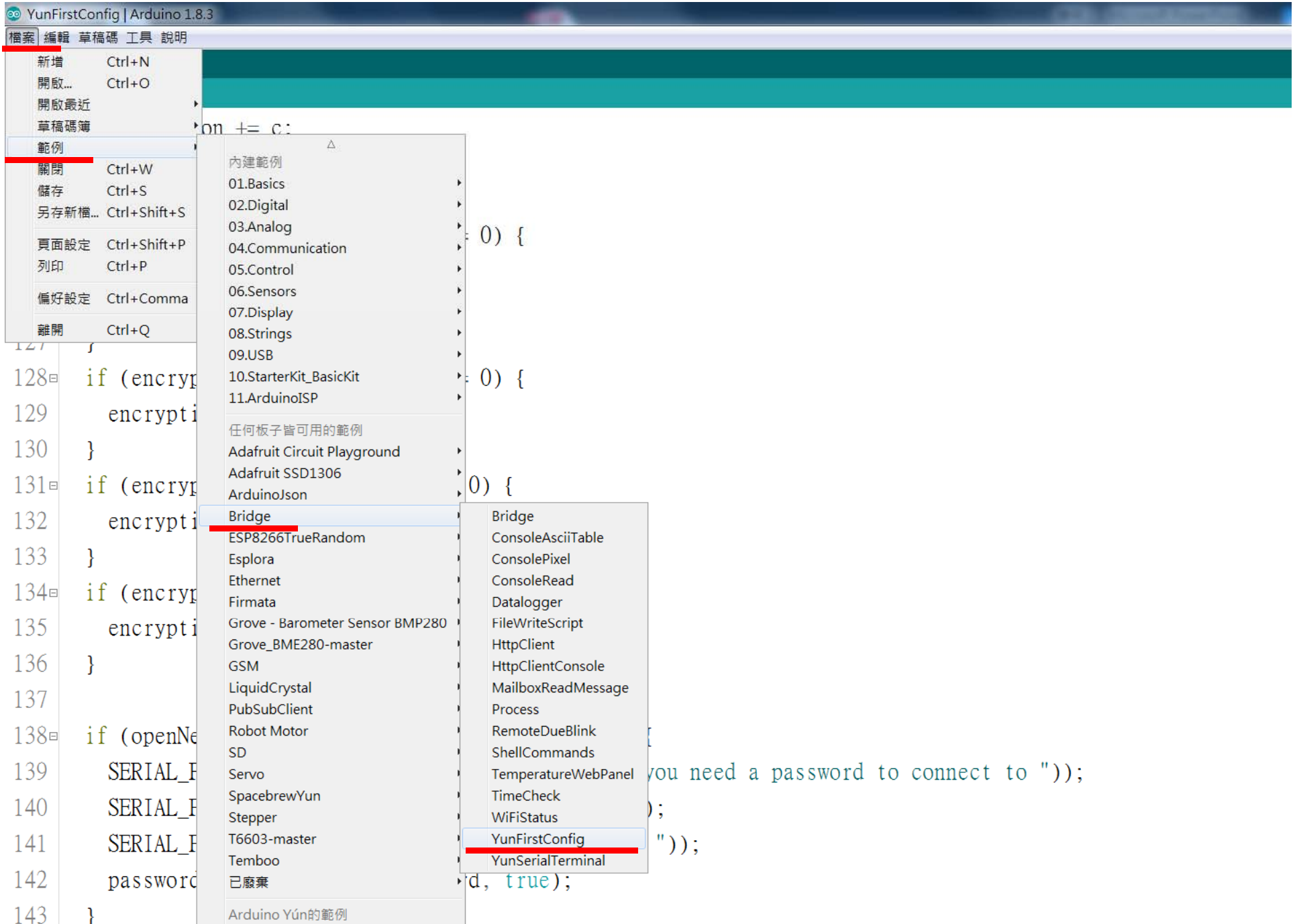

3.1. 上傳例程式YunFirstConfig到ArduinoYun板子上

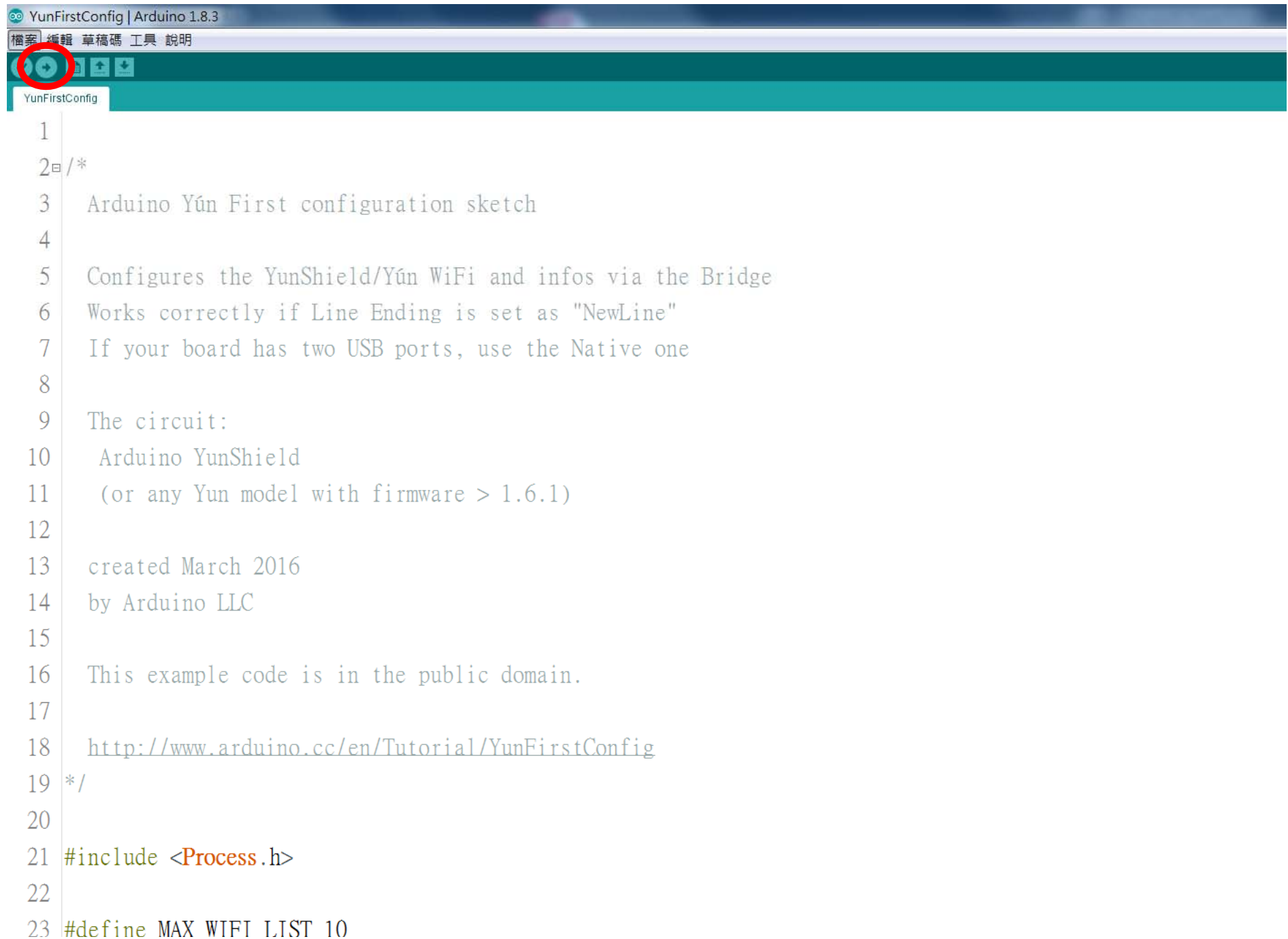

```
YunFirstConfig | Arduino 1.8.3
檔案 編輯 草稿碼 工具 說明
YunFirstConfig
1
2 /*
3  Arduino Yún First configuration sketch
4
5  Configures the YunShield/Yún WiFi and infos via the Bridge
6  Works correctly if Line Ending is set as "NewLine"
7  If your board has two USB ports, use the Native one
8
9  The circuit:
10  Arduino YunShield
11  (or any Yun model with firmware > 1.6.1)
12
13  created March 2016
14  by Arduino LLC
15
16  This example code is in the public domain.
17
18  http://www.arduino.cc/en/Tutorial/YunFirstConfig
19  */
20
21 #include <Process.h>
22
23 #define MAX WIFI LIST 10
```

4. 斷電重開，選擇序列埠監控視窗

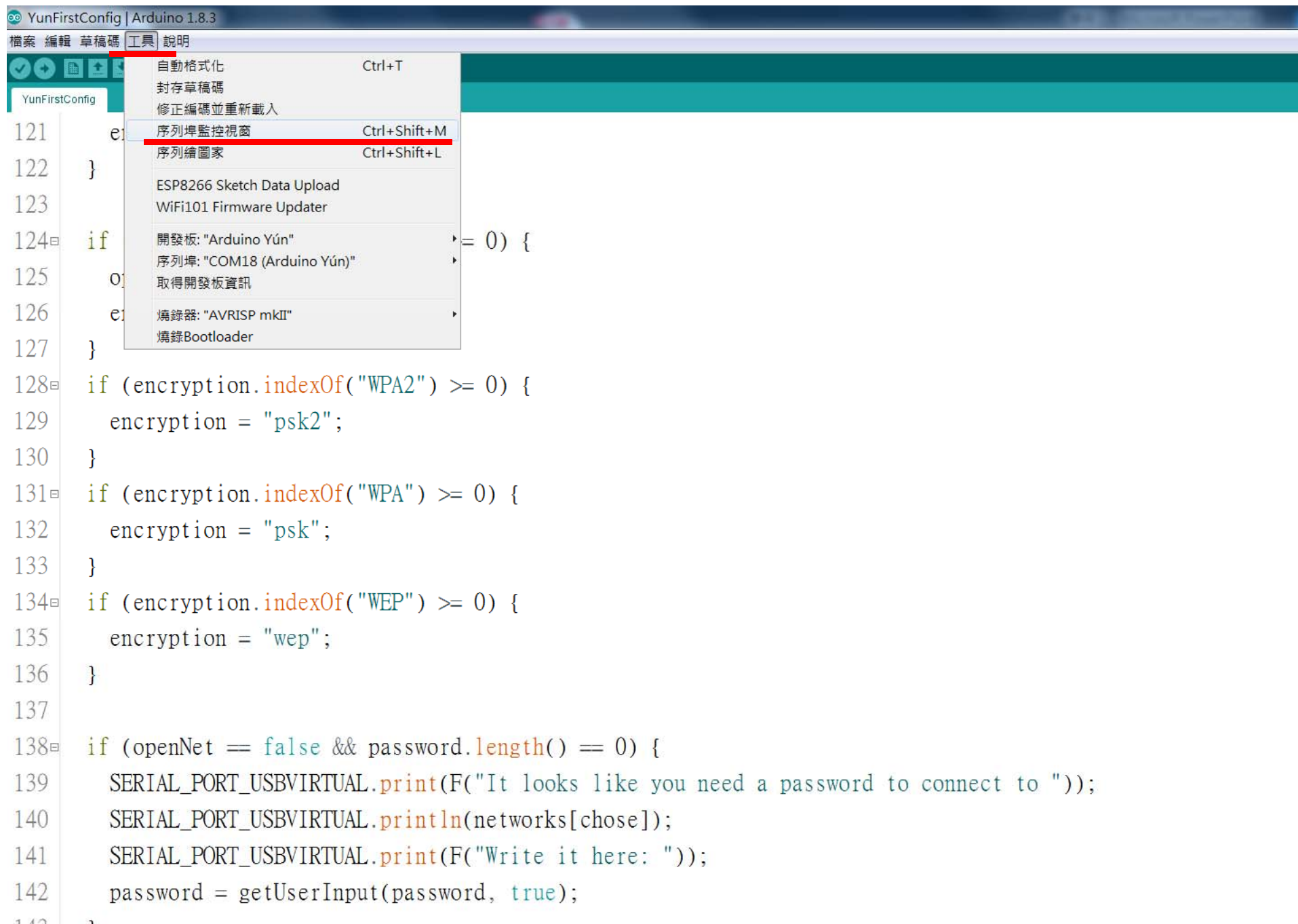

5. 序列埠監控視窗的通訊模式要選 **NL(newline), 115200 baud**

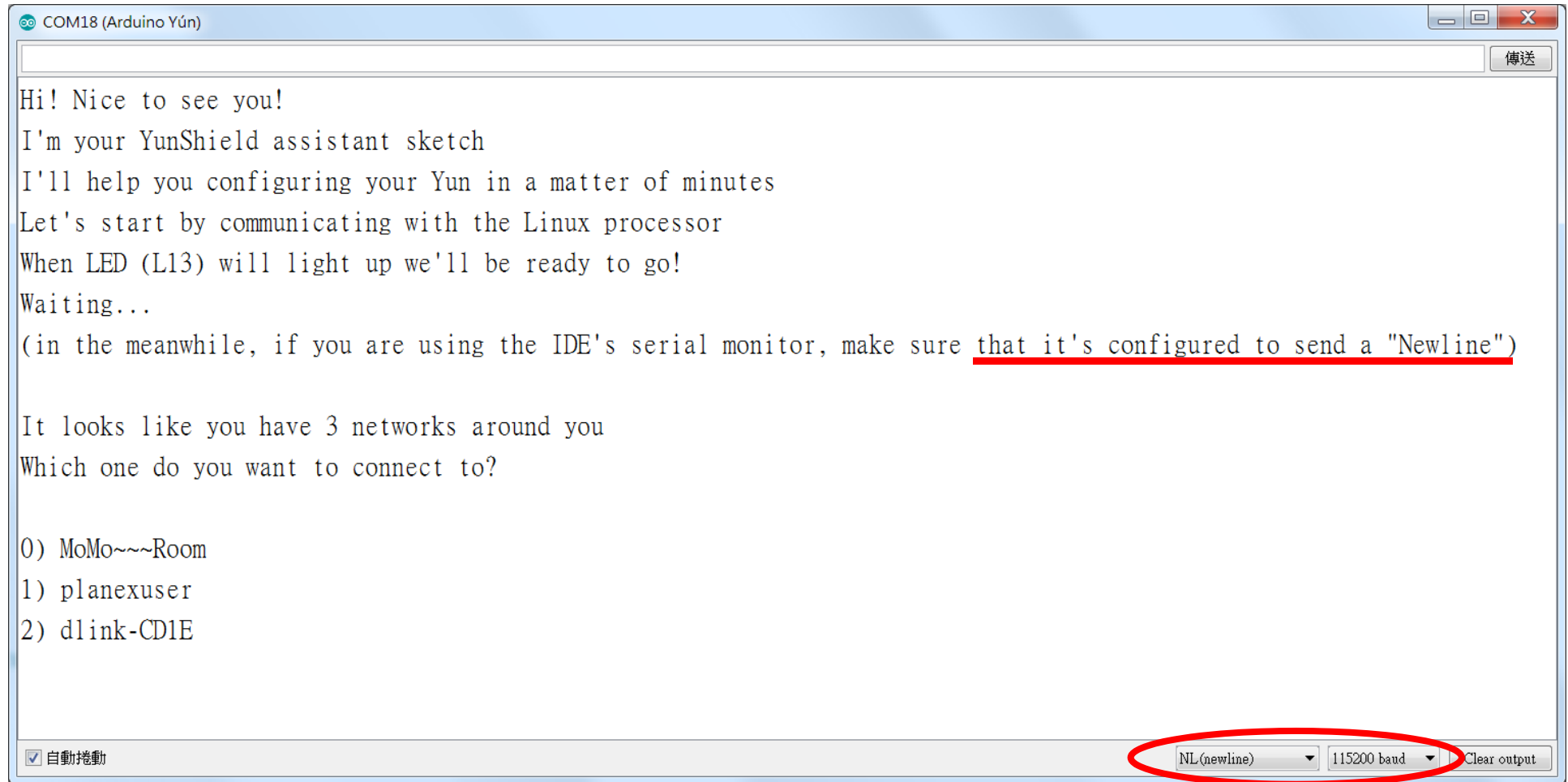

6. 於上方輸入框中依序輸入問題的答案，按下右邊的傳送鈕傳送
選擇正確 WiFi AP後，接著輸入密碼。

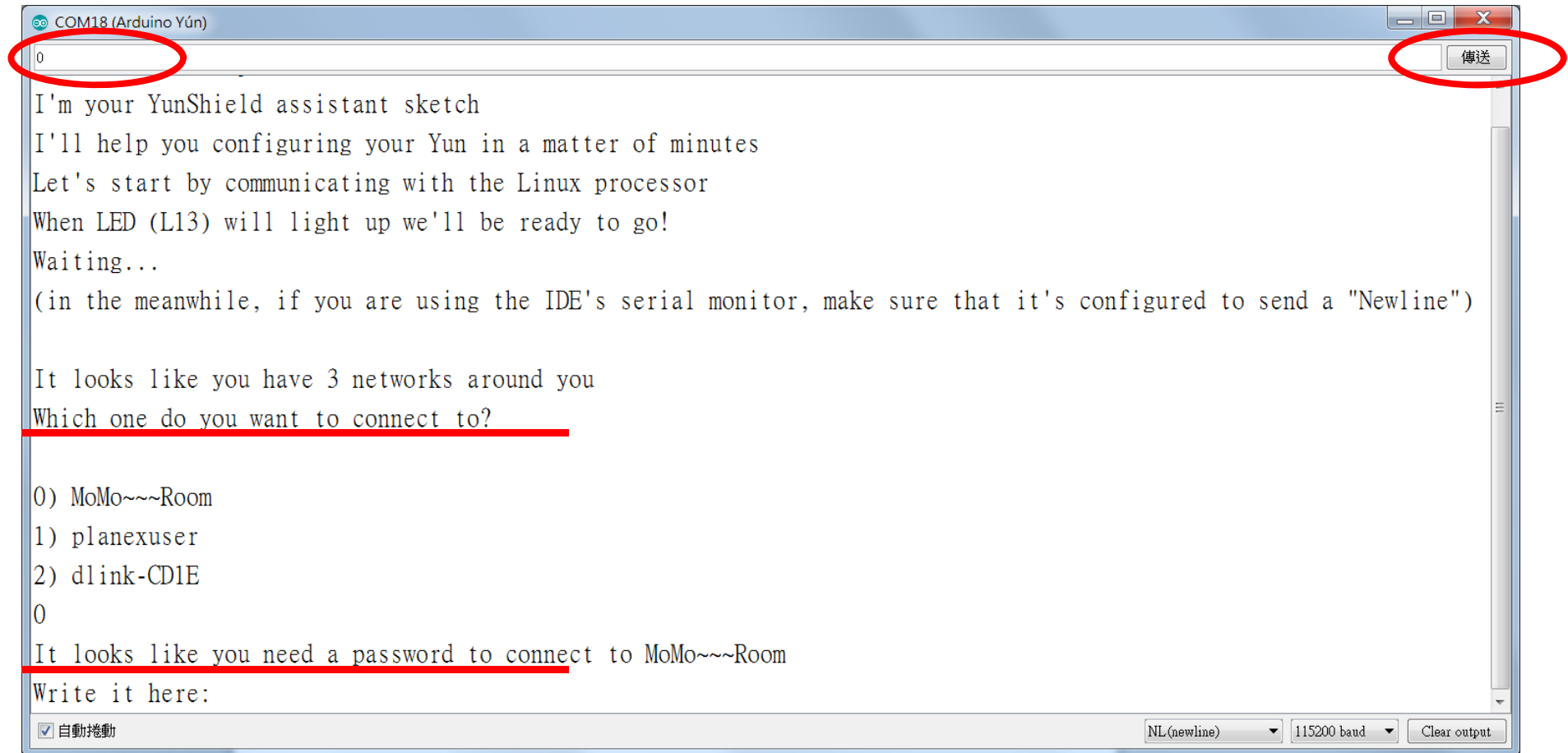

7. 設定登入帳號，請輸入 root

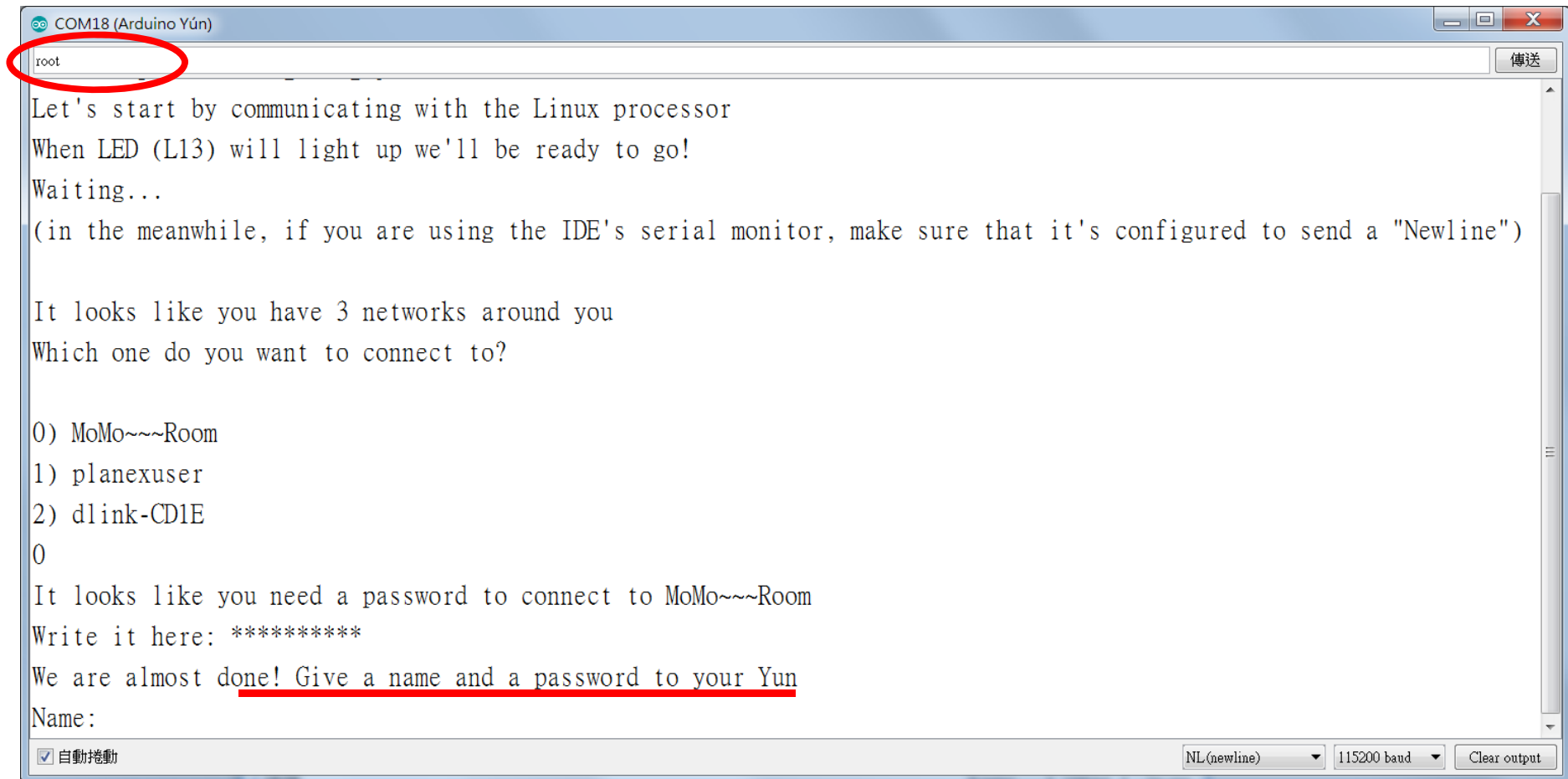

```
COM18 (Arduino Yún)
root
Let's start by communicating with the Linux processor
When LED (L13) will light up we'll be ready to go!
Waiting...
(in the meanwhile, if you are using the IDE's serial monitor, make sure that it's configured to send a "Newline")

It looks like you have 3 networks around you
Which one do you want to connect to?

0) MoMo~~~Room
1) planexuser
2) dlink-CD1E
0
It looks like you need a password to connect to MoMo~~~Room
Write it here: *****
We are almost done! Give a name and a password to your Yun
Name:

 自動捲動
NL(newline) 115200 baud Clear output
```

8. 設定登入密碼，請輸入 **arduino**

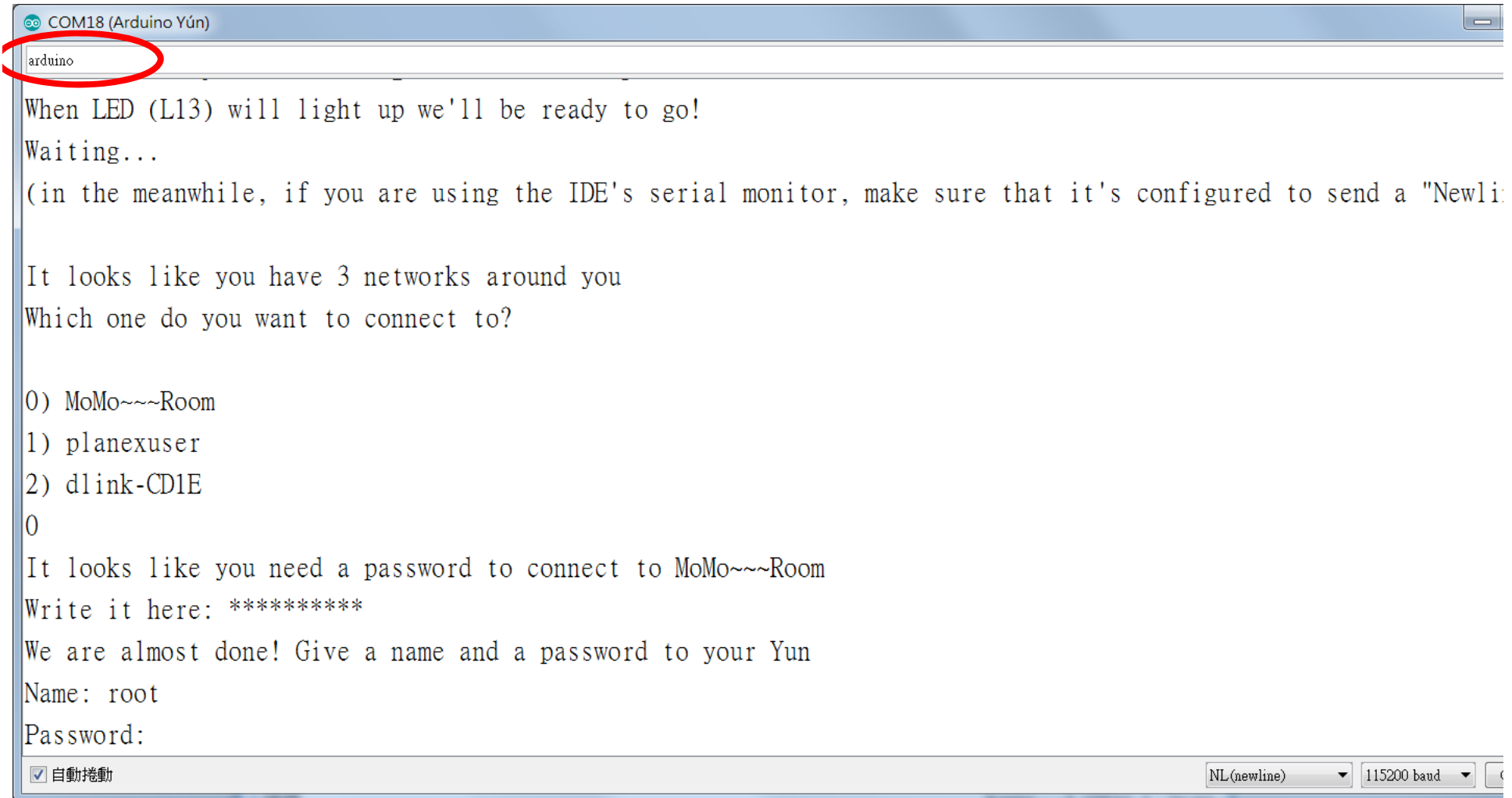

The screenshot shows a serial monitor window titled "COM18 (Arduino Yún)". The text inside the window is as follows:

```
arduino  
When LED (L13) will light up we'll be ready to go!  
Waiting...  
(in the meanwhile, if you are using the IDE's serial monitor, make sure that it's configured to send a "Newli:  
  
It looks like you have 3 networks around you  
Which one do you want to connect to?  
  
0) MoMo~~~Room  
1) planexuser  
2) dlink-CD1E  
0  
It looks like you need a password to connect to MoMo~~~Room  
Write it here: *****  
We are almost done! Give a name and a password to your Yun  
Name: root  
Password:
```

At the bottom of the window, there are controls for "自動捲動" (checked), "NL(newline)", and "115200 baud".

9. 國碼輸入TW

```
COM18 (Arduino Yún)
us
(in the meanwhile, if you are using the IDE's serial monitor, make sure that it's configured to send a "Newlin

It looks like you have 3 networks around you
Which one do you want to connect to?

0) MoMo~~~Room
1) planexuser
2) dlink-CD1E
0
It looks like you need a password to connect to MoMo~~~Room
Write it here: *****
We are almost done! Give a name and a password to your Yun
Name: root
Password: *****
One last question: where do you live?
Insert a two letters county code (eg IT, US, DE):
TW
```

自動捲動 NL(newline) 115200 baud CI

10. 記住畫面所顯示的板子IP

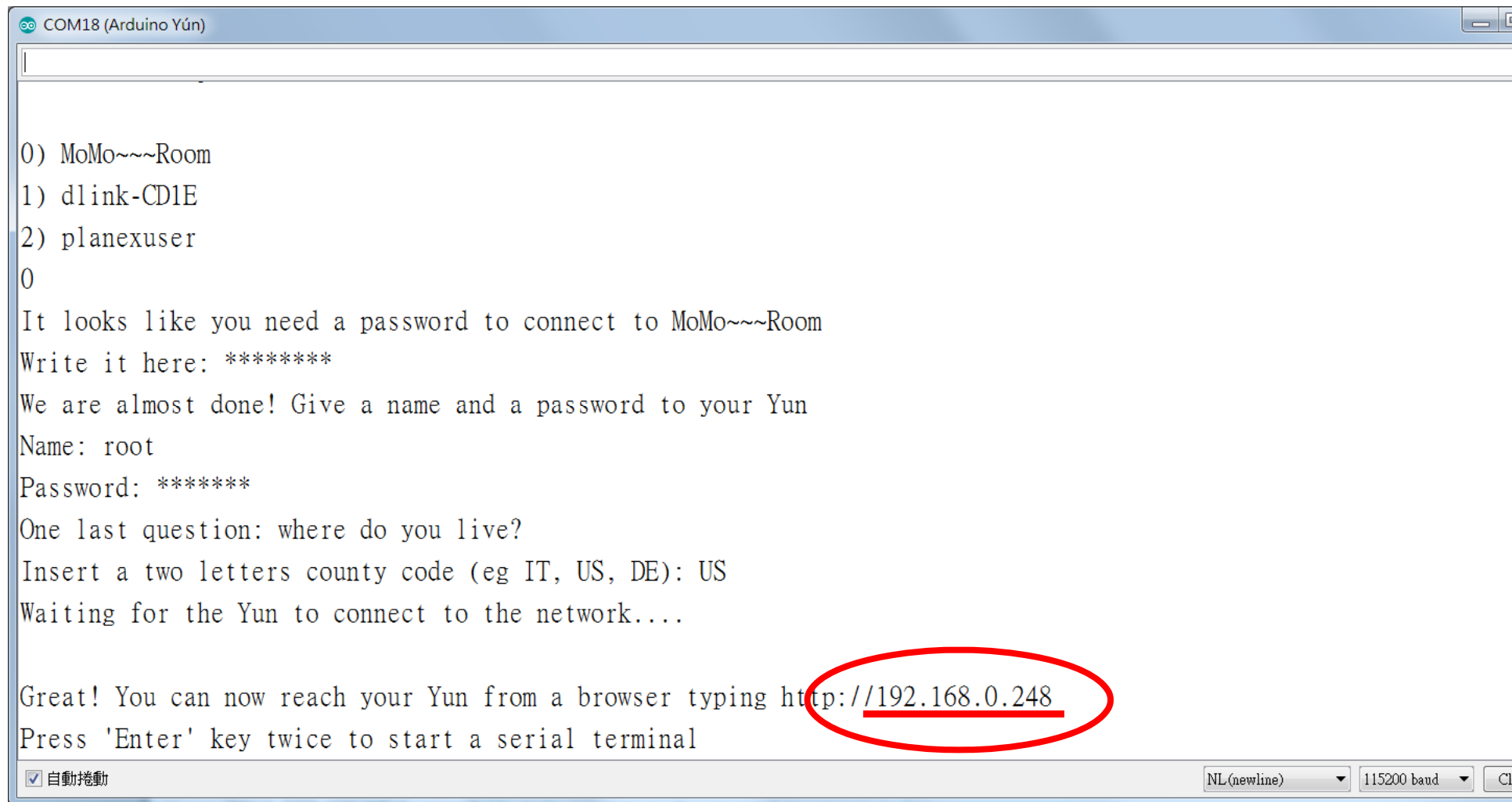

```
COM18 (Arduino Yún)

0) MoMo~~~Room
1) dlink-CD1E
2) planexuser
0
It looks like you need a password to connect to MoMo~~~Room
Write it here: *****
We are almost done! Give a name and a password to your Yun
Name: root
Password: *****
One last question: where do you live?
Insert a two letters county code (eg IT, US, DE): US
Waiting for the Yun to connect to the network....

Great! You can now reach your Yun from a browser typing http://192.168.0.248
Press 'Enter' key twice to start a serial terminal

 自動捲動
NL(newline) 115200 baud
```

Arduino Yun 連接 IoT talk

如何讓Arduino Yún 連結IoTtalk?

- Arduino Yún提供bridge架構，讓Linux環境與Arduino環境之間可以溝通
- Bridge架構

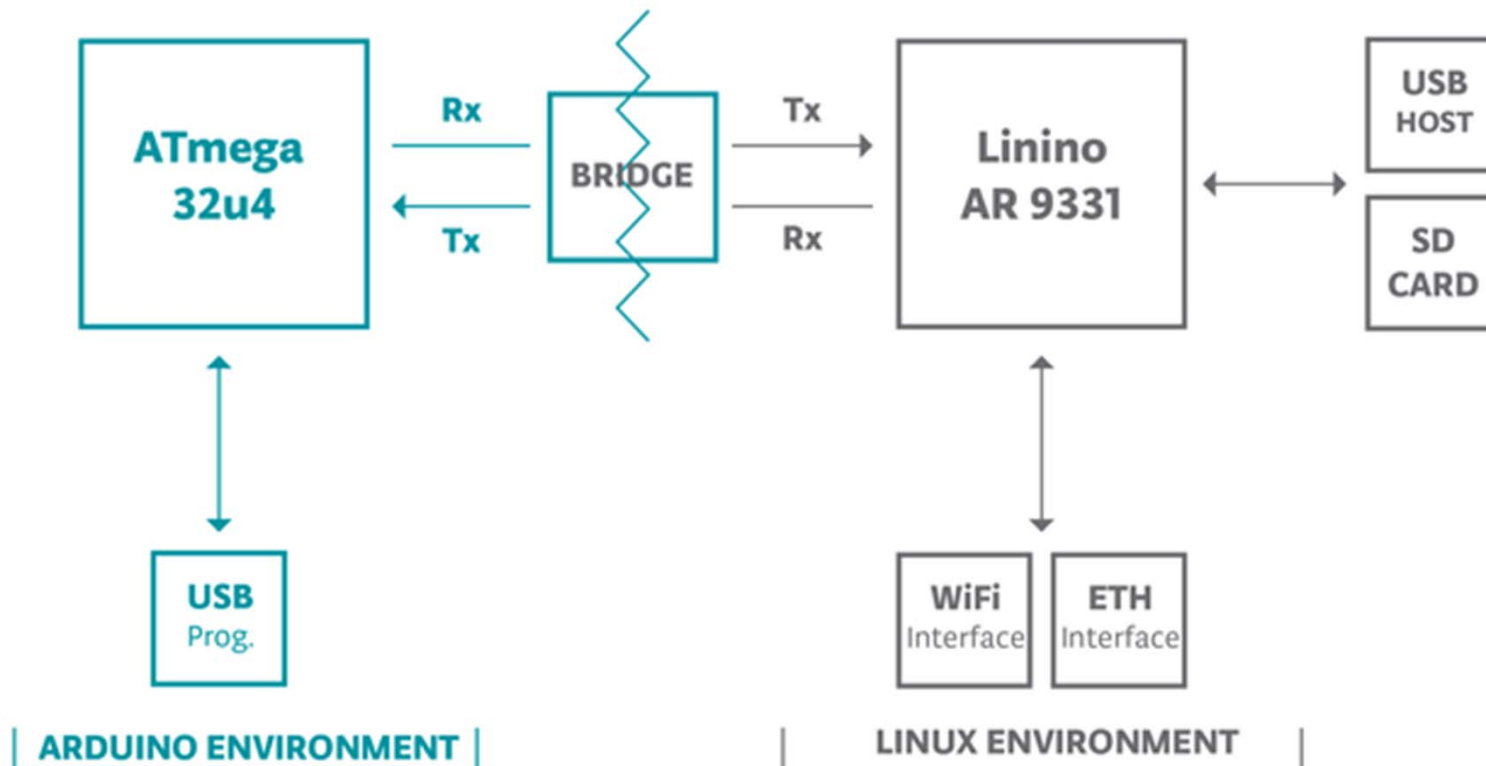

如何讓Arduino Yún 連結IoTtalk?

- 需在Arduino Yún板子中，載好與IoTtalk通訊的DAI.py, DAN.py, csmapi.py程式
- DAI: 負責與Arduino程式(IDA) 通訊
 - 使用者仍須修改custom.py來達成與IDA的通訊
- IDA: Arduino環境跑的程式
- DAN:負責跟IoTtalk通訊的程式

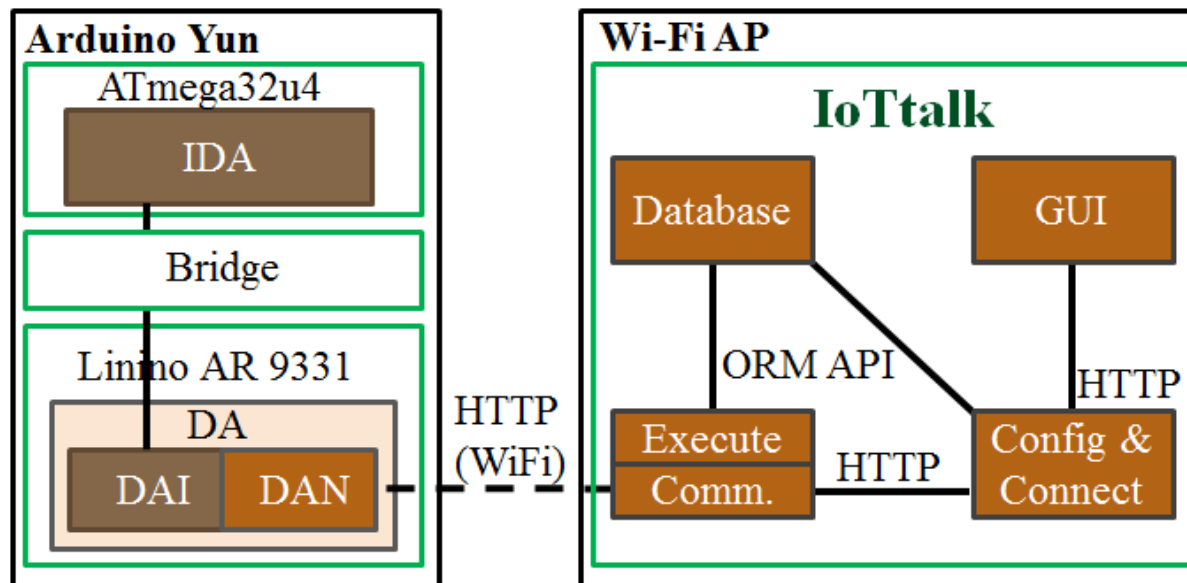

- DAI: device application to IoT device
- IDA: IoT device to device application
- DAN: device application to network

使用PuTTY連接Arduino Yún

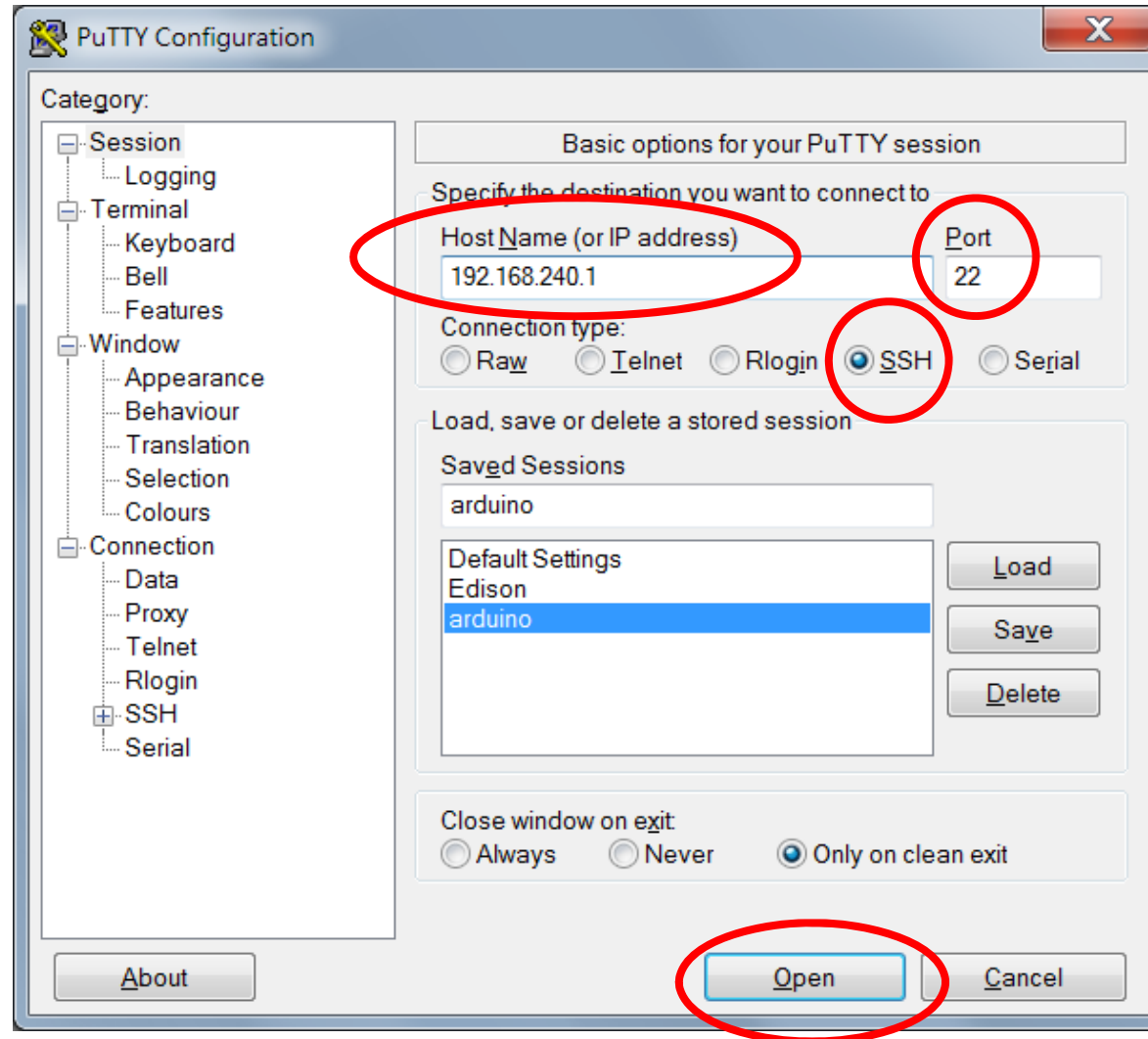

Google putty and download.

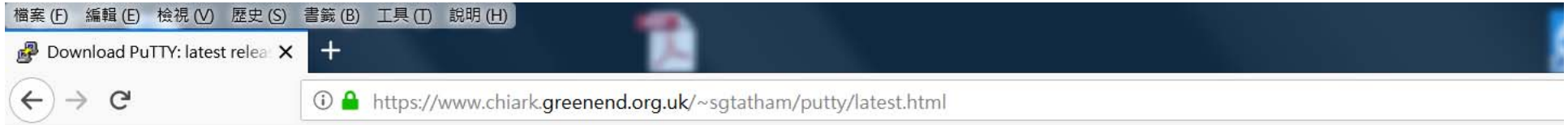

Download PuTTY: latest release (C

[Home](#) | [FAQ](#) | [Feedback](#) | [Licence](#) | [Updates](#) | [Mirrors](#) | [Key](#)
Download: [Stable](#) · [Snapshot](#) | [Docs](#) | [Changes](#) | [V](#)

This page contains download links for the latest released version of PuTTY. Currently this is 0.70, released on 2017-07-08.

When new releases come out, this page will update to contain the latest, so this is a good page to bookmark or link to. Alternatively, here is a [permanent link to the 0.70 release](#).

Release versions of PuTTY are versions we think are reasonably likely to work well. However, they are often not the most up-to-date version of the code available. If you have a p those versions.

Package files

You probably want one of these. They include all the PuTTY utilities.

(Not sure whether you want the 32-bit or the 64-bit version? Read the [FAQ entry](#).)

MSI ('Windows Installer')

32-bit: [putty-0.70-installer.msi](#) [\(or by FTP\)](#) [\(signature\)](#)

64-bit: [putty-64bit-0.70-installer.msi](#) [\(or by FTP\)](#) [\(signature\)](#)

Unix source archive

.tar.gz: [putty-0.70.tar.gz](#) [\(or by FTP\)](#) [\(signature\)](#)

Alternative binary files

登入Arduino Yún 上的Linino

- 帳號：root
- 密碼：arduino

The image shows two side-by-side screenshots of a PuTTY terminal window. The left screenshot shows the initial login prompt: 'login as: root' followed by 'root@192.168.240.1's password:' and a green cursor. The right screenshot shows the same login process, but with the password entered and the terminal displaying 'BusyBox v1.19.4 (2014-11-13 19:03:47 CET) built-in shell' and 'Enter 'help' for a list of built-in commands.' Below this, there is a large ASCII art graphic of a computer monitor with the text 'W I R E L E S S F R E E D O M' written across the screen. At the bottom of the right screenshot, the prompt 'root@Arduino:~#' is displayed with a green cursor.

設置python執行環境，安裝requests

請參考 <https://github.com/IoTtalk/Arduino-da>

opkg update

opkg install python-pip

wget http://yun.iottalk.tw/idna2.8.tar.gz

tar zxvf idna2.8.tar.gz

cd idna-master

python setup.py install

pip install requests

opkg install openssh-sftp-server

**註：上方指令別直接複製貼上，因為 - 符號會是錯誤的，
- 符號請從鍵盤手動輸入**

下載ArduinoYun Rev. 2連接 IoTtalk的程式，並用FTP軟體上傳到ArduinoYun Linux端
<https://github.com/IoTtalk/ArduTalk-for-ArduinoYun/tree/master/Rev2>

Arduino端要燒入的程式範例

https://github.com/IoTtalk/ArduTalk-for-ArduinoYun/tree/master/sketch_apr17a

The screenshot shows a web browser window displaying the GitHub repository page for `IoTtalk/Arduino-da`. The browser's address bar shows the URL `https://github.com/IoTtalk/Arduino-da`. The repository page includes a search bar, navigation links for Pull requests, Issues, Marketplace, and Explore, and repository statistics: 63 commits, 1 branch, 0 releases, and 1 contributor. A 'Clone or download' button is highlighted in green, and a dropdown menu is open, showing options to 'Clone with HTTPS' (with a URL `https://github.com/IoTtalk/Arduino-da.git`) and 'Download ZIP'. The file list includes `Arduino_code_example`, `Rev2`, `DAI.py`, `DAN.py`, `README.md`, and `autoStart.py`.

設定Device Feature, Model, 與 Arduino傳遞資訊的變數

- 指令：vim custom.py

```
192.168.240.1 - PuTTY  
root@Arduino:~# vim custom.py
```

```
192.168.240.1 - PuTTY  
import DAN  
  
def update_profile():  
    DAN.profile['dm_name']='Arduino'  
    DAN.profile['d_name']='Arduino Yun'  
    DAN.profile['df_list']=['Pin', 'Camera_angle']  
  
def assign():  
    return [  
        ('Pin', 0, 'PIN'),  
        ('Camera_angle', 1, 'Reg_done'),  
    ]
```

~
~
~

想要傳送的 Device feature

Device feature的維度

與Arduino中透過bridge傳遞的共通變數名稱，意即此變數在Arduino中也要一模一樣。IoTtalkt將device feature傳進此放在bridge中的變數(假設是PIN)在Arduino端就可在bridge中，從變數PIN取出數值

透過Bridge傳遞Output Device Feature 數值到Arduino

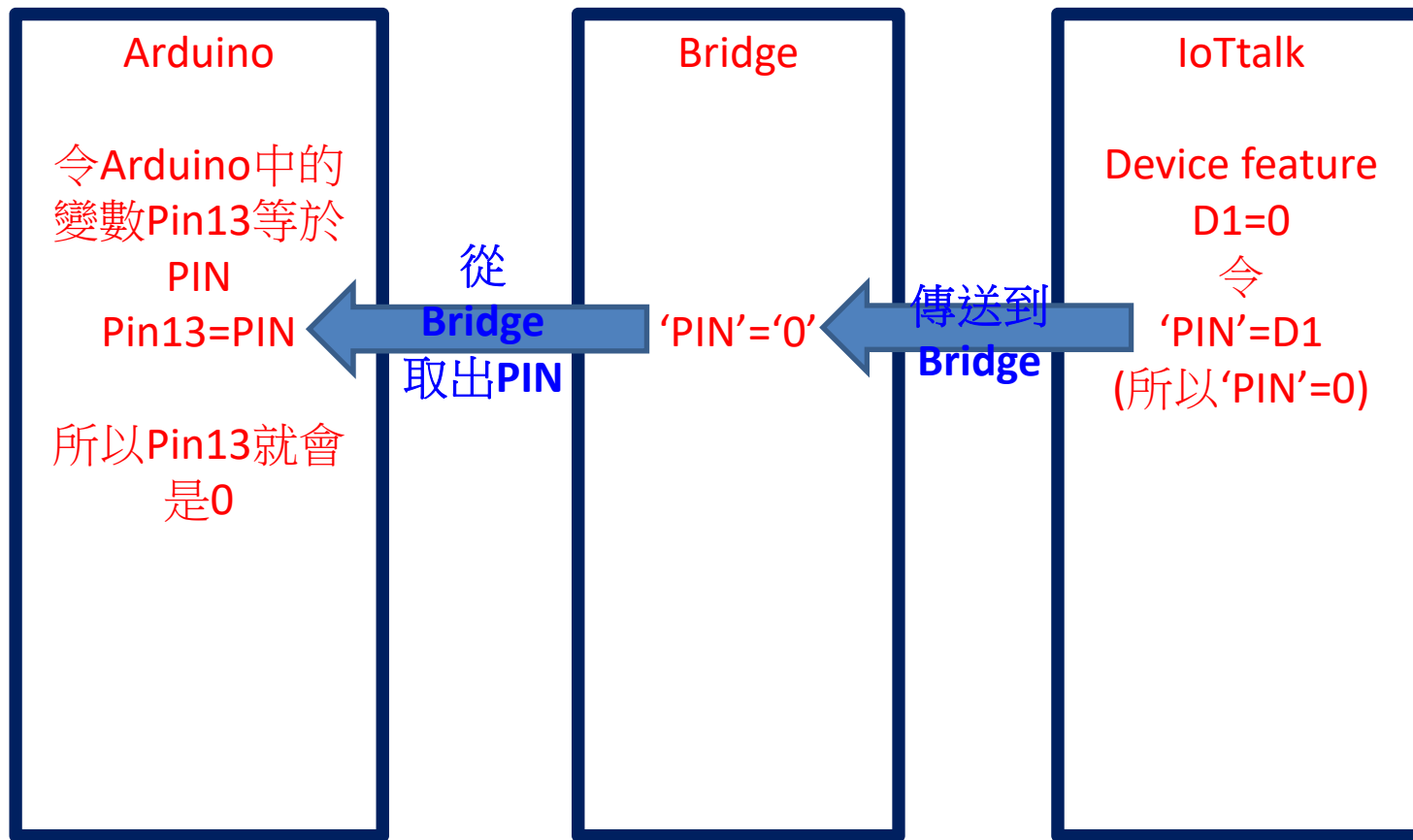

執行DAI.py連結IoTtalk

- 指令：`python DAI.py`

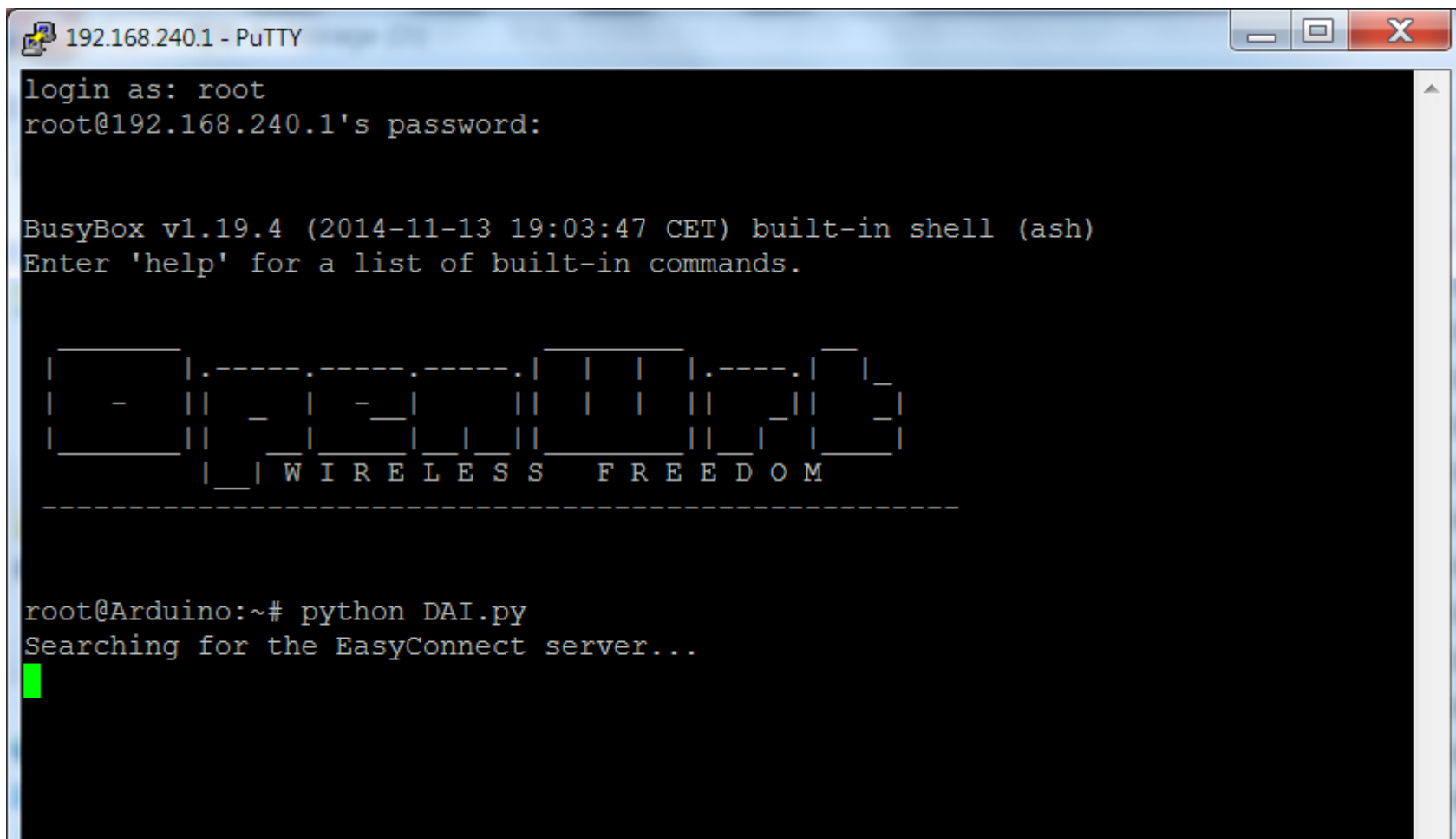

```
192.168.240.1 - PuTTY
login as: root
root@192.168.240.1's password:

BusyBox v1.19.4 (2014-11-13 19:03:47 CET) built-in shell (ash)
Enter 'help' for a list of built-in commands.

[ ASCII Art Logo ]
-----
root@Arduino:~# python DAI.py
Searching for the EasyConnect server...
█
```

設定Arduino Yún通電後自動連結IoTtalk

執行 `python autoStart.py`

`autoStart.py`會在 `/etc/rc.local` 加入一行

```
(sleep 0;python -u /root/DAI.py)&
```

避免下列行為，以免燒掉Arduino

1. 將任一個 I/O Pins 與 GND 連接形成短路
2. 將 I/O Pins 相互連接
3. 將過大的電壓導引到 I/O Pins 上
4. 外部電流反接
5. 電源由 5V 針腳導入,且外部電源電壓大於 5V
6. 電源由 3.3V 針腳導入,且外部電源電壓大於 3.3V
7. 連接 Vin 與 GND
8. 提供超過 13V 到 Reset Pin 上
9. 超過微控制器所能負載之電流量(200ma)